

<b>SPECIFICATION</b>	<b>MESSRS.</b>
----------------------	----------------

<b><u>DEVICE TYPE NAME</u></b> Sanken Hybrid Voltage Regulator Module - STR58041A(LF502)
---

**1. Scope**

The present specifications shall only apply to Sanken Hybrid Voltage Regulator, type STR58041A.

**2. Features**

- a) Hybrid Voltage regulator module with a triple diffused planar transistor incorporated.
- b) For TV switch mode power supply application.
- c) Fixed output Voltage.

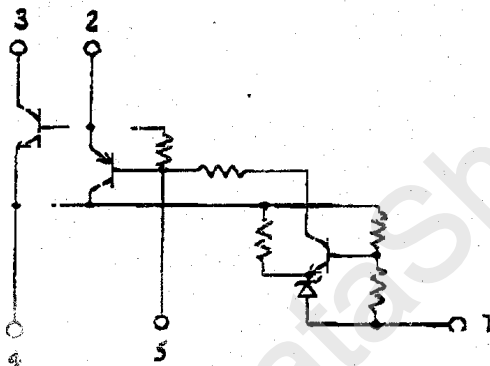
**3. Equivalent circuit**

- 1. Vout SENSE (-)
- 2. BASE DRIVE (B)
- 3. INPUT (C)
- 4. EARTH (E)
- 5. Reference Adjust

4. Outline, dimension and pin connection are per Fig.1

5. The type number and lot number shall be marked in white.

DATE ISSUED: Aug. 21, 1996	APPLICATION ENGINEERING	2/18
PREPARED BY: <i>Tatsumi Takasashi</i>	SEMICONDUCTOR DIVISION	
CHECKED BY: <i>Hitao Ueki</i>	SPECIFICATION NUMBER	
CHECKED BY: <i>W. G. ...</i>	SSE-20361E	

**6. Absolute Maximum Ratings(Ta=25°C)**

Characteristic	Symbol	Unit	Ratings	
Collector-Emitter Voltage	V <sub>CEX</sub>	V	650	(*1)
Input Current	I <sub>IN</sub>	A	6 (pulse 12)	
Maximum Power Dissipation	P <sub>D</sub>	W	27 (T <sub>F</sub> -100°C)	
Operating Temperature	T <sub>OP</sub>	°C	-20~+103 (T <sub>F</sub> )	(*2)
Storage Temperature	T <sub>stg</sub>	°C	-40~+125	
Power Tr Junction Temp.	T <sub>j</sub>	°C	+150	

(\*1) V<sub>CEO</sub>=6(K)V Min (Reference value)

(\*2) Refer to the accelerated data of TFT (Thermal Fatigue Test) on Page.16 for thermal design.

**7. Electrical Characteristics(Ta=25°C)**

Characteristic	Symbol	Test Conditions	Rating
Fixed Output Voltage.	V <sub>S</sub>	I <sub>IN</sub> =7mA, Test Circuit 1	41.8±0.5V
Output Voltage Temperature Coefficient		T <sub>C</sub> =-20~+100°C I <sub>IN</sub> =7mA, Test Circuit 1	±2.0mV/°C
Collector Saturation Voltage	V <sub>CE(sat)</sub>	I <sub>C</sub> =2A, I <sub>B</sub> =0.4A	0.4V Max
DC Current Gain	h <sub>FE</sub>	V <sub>CE</sub> =4V, I <sub>C</sub> =1A	Min 13 Max 38
Collector Cutoff Current	I <sub>CEX</sub>	V <sub>CE</sub> =650V, V <sub>BE</sub> =-1.5V	250μA Max
Collector-Emitter Voltage	V <sub>CEX</sub>	I <sub>CEX</sub> =1.0mA, V <sub>BE</sub> =-1.5V	850V Min
Base-Emitter Sat. Voltage	V <sub>BE(sat)</sub>	I <sub>C</sub> =2A, I <sub>B</sub> =0.4A	1.5V Max
Thermal Resistance	θ <sub>jF</sub>	Junction to metal frame	1.8 °C/W
Switching Time	Test Circuit 2	t <sub>s</sub>	11.0μsec Max
		t <sub>f</sub>	0.5μsec Max

※ Power Transistor Characteristics

8. Application Circuit Example(Refer Circuit)

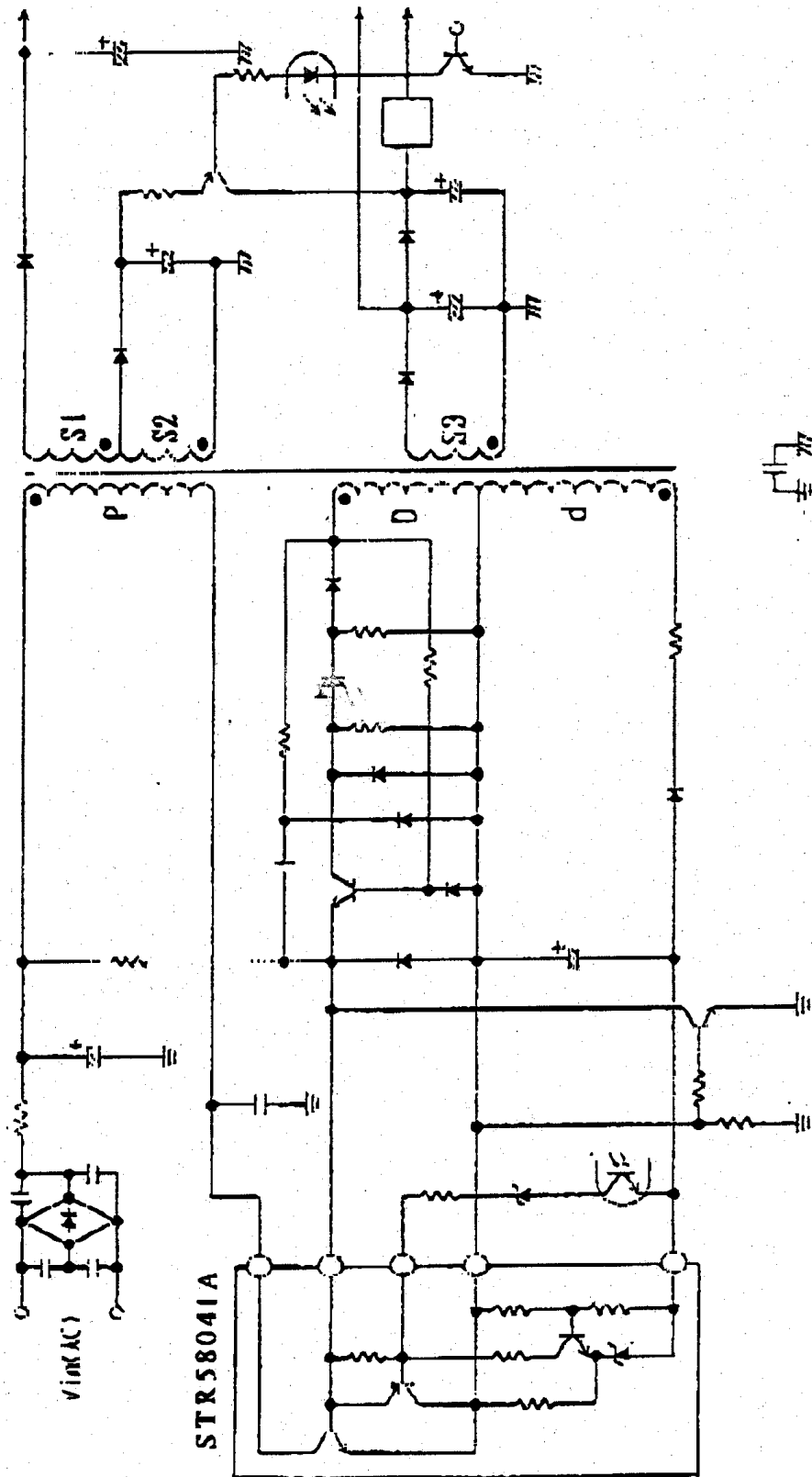

**9. Method to the mounting a heatsink**

1) Recommended screw torque 6 ~ 8 [kg·f·cm]

2) Recommended silicone grease

G-746 (SHINETSU CHEMICAL INDUSTRIES Co., Ltd.)

YG6260 (TOSHIBA SILICONE Co., Ltd.)

SC102 (DAW CORNING TORAY SILICONE CO.,LTD.)

**10. Others**

Since this device is developed and produced for general purpose , radioactive ray design has not been considered.

**Test Circuit 1 : Fixed Output Voltage Test Circuit**

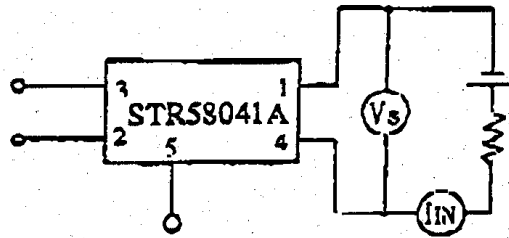

**Test Circuit 2 : Switching Time Test Circuit**

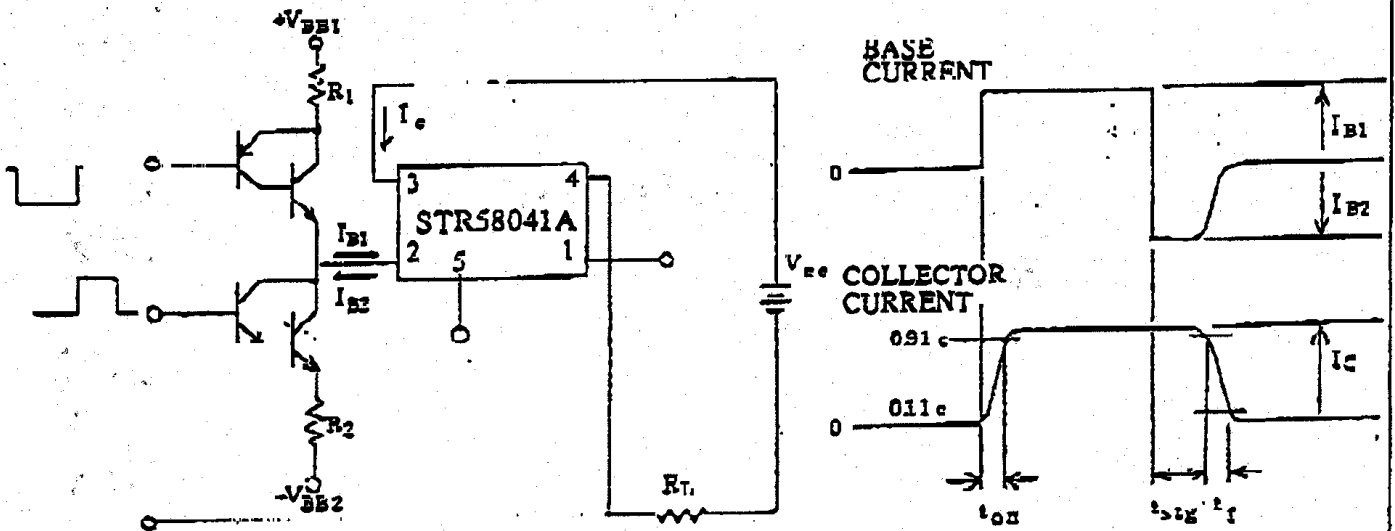

$I_C = 2A, R_L = 100\Omega$

$I_{B1} = 400mA, I_{B2} = 400mA$

**Fig-1 : Outline Drawings, Dimensions and Pin Connections**  
Sanken Lead Forming No. : LF502

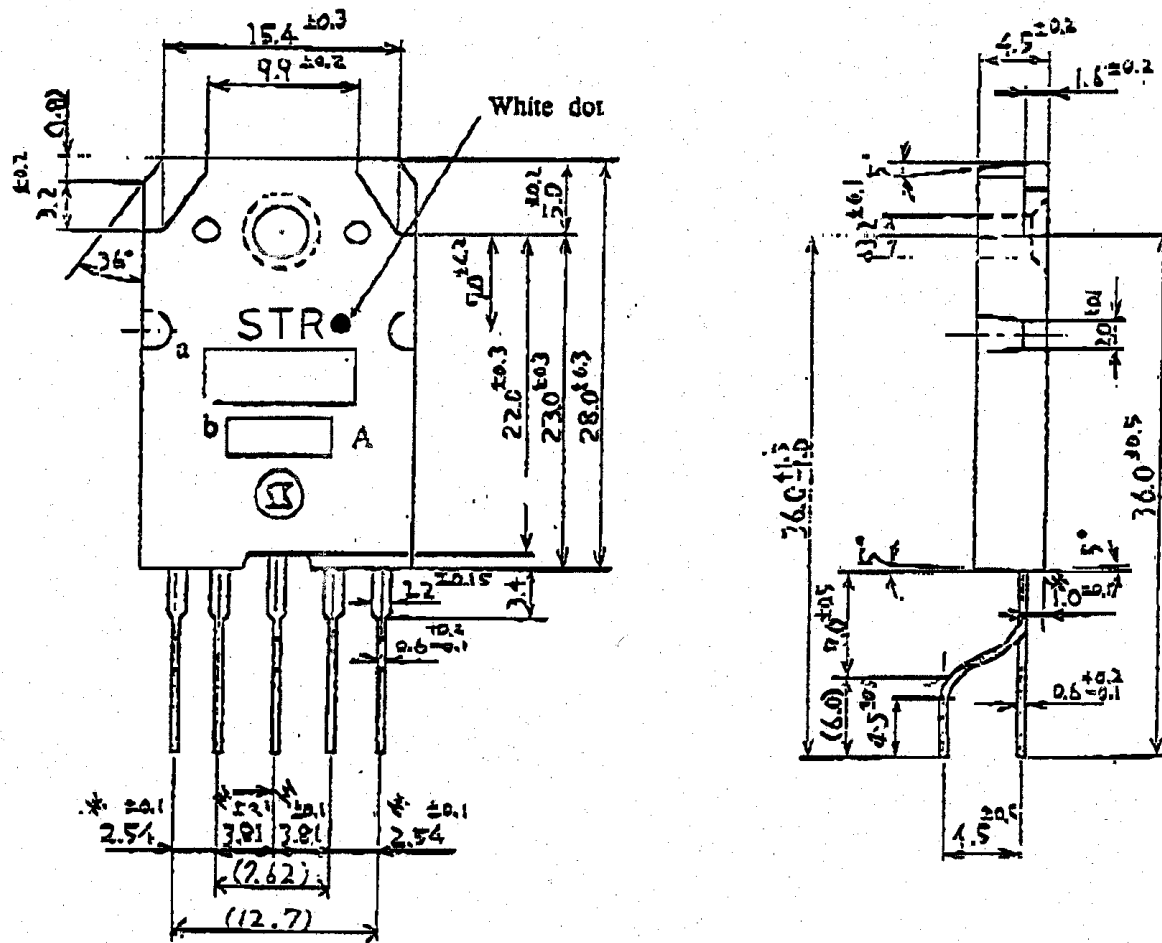

a : Type number 58041

b : Lot number 1st letter - The last digit of year  
2nd letter - Month

(1 to 9 for Jan. to Sept.,

O for Oct., N for Nov. and D for Dec.)

3rd & 4th letter - Day

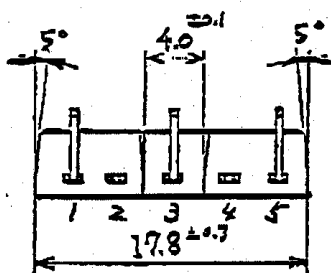

1. Vour SENSE (-)
2. BASE DRIVE (B)
3. INPUT (C)
4. EARTH (E)
5. Reference Adjust

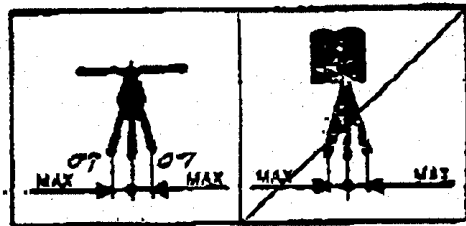

Remarks : The dimensions marked \* is measured at the base of lead wires.

Dimensions in mm

SSE-20361E

10/18